

Cable thermocouple type K with PVC cable

Order nr.: 803550 1211

Cable thermocouples with PVC cable are the most cost-effective solution for many applications up to +105 °C. If other temperatures or higher flexibility are required, cables made of silicone, glass fibre or PFA are used. To order your cable thermocouple, simply select the required configuration features and submit the order code.

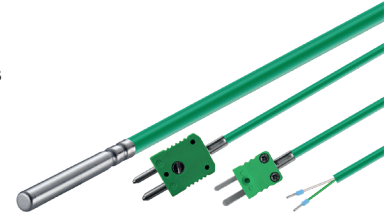

General Information	
Measuring range	-30 °C to +105 °C depending on chosen connection cable
Perm. °C range cable	-30 °C to +105 °C
Accuracy	-40 °C to +375 °C: ±1,5 °C according to DIN IEC 60584 Class 1
Response time	t63 / t99: information is available on request
Pull-out force	≥ 30 N
Supply and output	
Measuring element	Thermocouple Type K
Measuring point	Measuring point isolated
Measurement signal	Thermovoltage
Ambient conditions	
Protection class	IP65 according DIN 60529
Humidity and moisture condensation resistance	according to application-specific qualification
Certificates and Standards	
Standards	DIN EN 61326-1:2013 DIN EN IEC 63000:2019-05
Directive	RoHS 2011/65/EU 2014/30/EU
Certificates	Certificate of suitability (on request)



Customizable options

- C - Length protection sleeve
- D - Ø protection sleeve
- E - Material connection cable
- F - Length connection cable
- G - Connector
- H - Bend protection

Protection sleeve									
Bild	Material and possible configuration					C - Length prot. sleeve		D - Ø prot. sleeve	
	Length / Ø (mm)	3	4	5	6	Code	Length (mm)	Code	Ø (mm)
	30	-	-	1.4404	1.4404	C0030	30 ¹⁾	D050	5,0 ²⁾
	40	-	-	1.4404	1.4404	C0040	40 ¹⁾	D060	6,0 ²⁾
Zeichnung	50	-	-	1.4404	1.4404	C0050	50 ¹⁾		
	60	-	-	-	1.4571	C0060	60 ¹⁾		
	100	-	-	1.4571	1.4571	C0100	100 ¹⁾		
	200	-	-	1.4571	1.4571	C0200	200 ¹⁾		

1.4571 = 316TI | 1.4404 = 316 L | ¹⁾Tolerance C ≥ 100: ± 1 mm / C > 100: ± 1 % | ²⁾Tolerance ± 0,1 mm | other protective sleeve lengths and Ø available on request

E - Cable material and configuration connection cable												
Code	Type	Color	IP	From (°C) ¹⁾	To (°C) ¹⁾	Outside material	Material strand	Ø (mm) ²⁾	Q (mm ²)	Color strand	Ω / m ⁴⁾	
E8020	Thermocouple cable	Type K ³⁾	IP67	-30	+105	PVC	PVC	3,8	0,22	gn, wt	4,50	

Insulation resistance: ≥ 100 MOhm at min. 100 VDC | ¹⁾Perm. range °C | ²⁾Tolerance ± 0,2 mm | ³⁾Color according to IEC 584 | ⁴⁾per thermocouple

F - Length									
Code	F010	F020	F030	F040	F050	F100	F150	F200	
m	1	2	3	4	5	10	15	20	

RS / KS / 28.10.2021



G - Connector					
Picture	Code	Feature	Picture	Code	Feature
	G01	Insulated end ferrules (50 mm)			
	G12	Mini-TC connector Type K gn		G32	TC connector Type K gn
	G19	Mini-TC connector Type K ye		G39	TC connector Type K ye

Other connectors available on request

H - Bend protection		
Picture	Length (mm)	Material
	50	Stainless steel spring 1.4310 SUS 302
	Code	Feature
	H0	Without (Standard)
¹⁾ on request	H1	Metal bend protection ¹⁾

Your order code						
Order nr.	Length protection sleeve	Ø protection sleeve	Material connection cable	Length connection cable	Connector	Bend protection
803550 1211	C_____	D_____	E_____	F_____	G_____	H_____

Delivery and Assembly	
Delivery and Packagingw	Probe, separately packaged in PE bag
Assembly instructions	by using compression fitting or immersion sleeve

Important assembly advices	
	<p>Installation by means of compression fitting: Please tighten the union nut of the compression fitting by hand as far as it will go (clearly noticeable). For compression fittings with PTFE pressure ring, please make a 1/4 turn with a wrench suitable for the width across flats. These compression fittings can be used several times in this way. In the case of compression fittings with stainless steel cutting ring, the compression fitting connects to the protection tube. This connection is pressure resistant up to 40 bar. However, the compression fitting can only be used once. It must also be tightened more firmly. Please tighten it with 1 3/4 turns.</p>

Mounting by using an immersion sleeve (4): Please note that the Ø and the length of the immersion sleeve must be selected to suit the installation situation so that the minimum immersion depth can be achieved. Since the probe is not inserted directly into the medium, but via the immersion sleeve, the response times are somewhat slower. The probe should be selected in such a way that the protection sleeve touches the bottom of the immersion sleeve and that the air cushion around the protection sleeve is as small as possible. The use of thermal paste can improve the response times.

Please lay the cable with reserve loop (4) and in such a way that no water can penetrate the sensor head. This allows you to extend the probe without disconnecting the electrical connection.

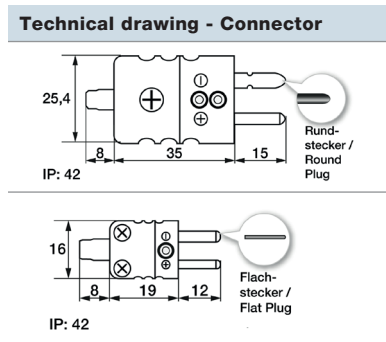

Technical drawing (All dimensions in mm)

Customizable options

- C - Length protection sleeve
- D - Ø protection sleeve
- E - Material connection cable

- F - Length connection cable
- G - Connector
- H - Bend protection

All dimensions in mm

Version with insulated end ferrules

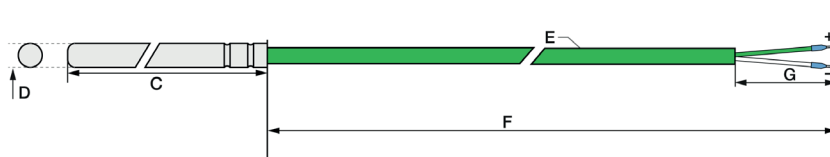

Version with mini TE connector



Version with TE connector



Version with mini TE connector

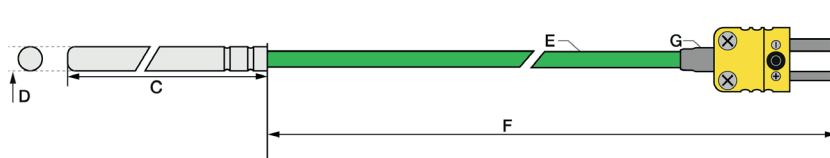

Version with TE connector

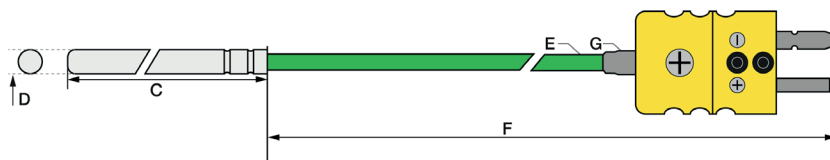

Matching accessories: Immersion sleeves

Brass immersion sleeve R1/2 "				
Article no.	809520 10XX	Code		
Temp. max	+150 °C	05	50	
Pressure proof up to	10 bar	10	100	
Material	Nickel plated	15	150	
Process connection	R1/2 "	20	200	
Wrench size	22	25	250	
Ø Inside / Outside (mm)	6,5 / 8	30	300	
Scope of delivery	Immersion sleeve, packed in PE bag	40	400	
Order code	809520 10	--		

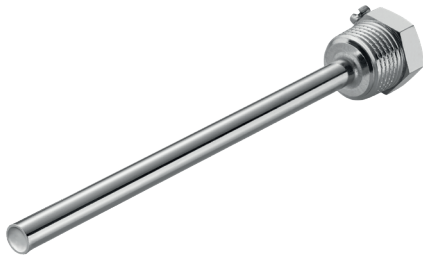

Please attach the code for the mounting length.

Technical drawing

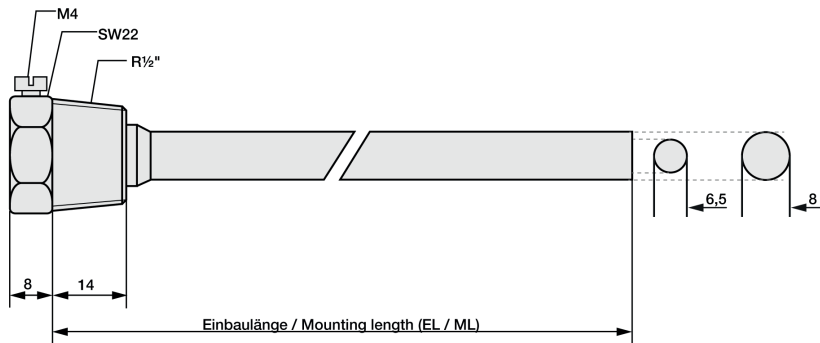

Stainless steel immersion sleeve G1/2 "				
Article no.	809520 20XX	Code		
Temp. max	+600 °C	05	50	
Pressure proof up to	40 bar	10	100	
Material	Stainless steel 1.4571 316TI	15	150	
Process connection	G1/2 "	20	200	
Wrench size	22	25	250	
Ø Inside / Outside (mm)	6,2 / 9	30	300	
Scope of delivery	Immersion sleeve, packed in PE bag	40	300	
Your order code	809520 20	--		

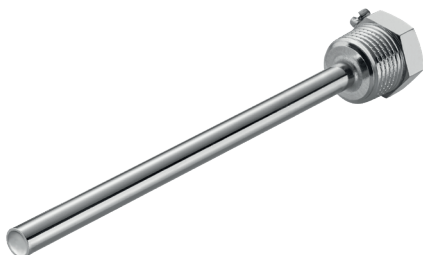

Please attach the code for the mounting length.

Technical drawing

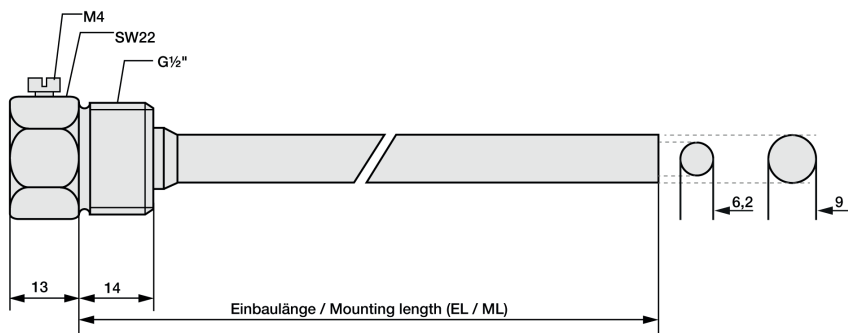

RS / KS / 28.10.2021



Matching accessories: Immersion sleeves

Immersion sleeve G1/2 " with cable gland					
Article no.	809520 60XX	Compression fitting		Code	
Temp. max	+600 °C	Temp. max	100 °C	05	50
pressure proof until	40 bar	Material	Plastic	10	100
Material	Stainless steel 1.4571 316Ti	Screw	M12 x 1,5	15	150
Process connection	G1/2 "	Clamping range (mm)	3 bis 6,5	20	200
Wrench size	22			25	250
Scope of delivery	Immersion sleeve, packed in PE bag	Cable gland	strain relief	30	300
				40	400
Your order code	809520 60			--	--

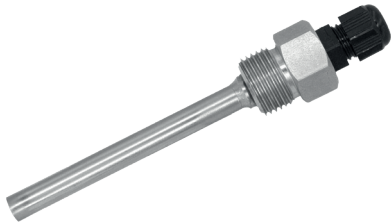

Please attach the code for the mounting length.

Technical drawing

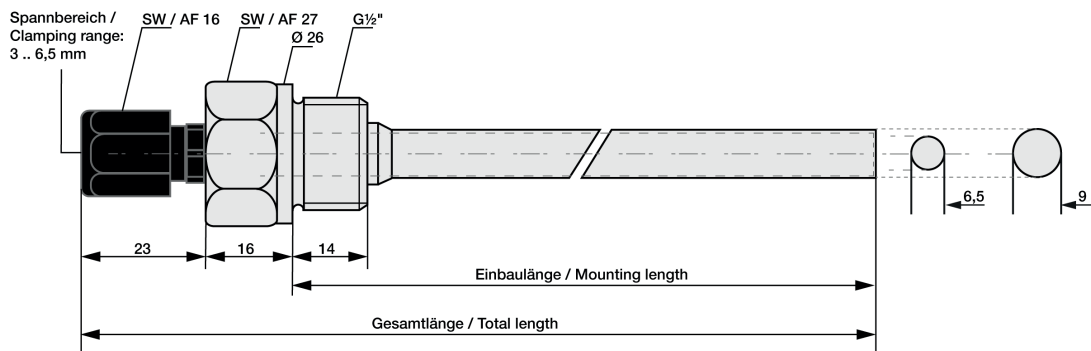

Matching accessories: Compression fittings

Compression fitting with PTFE clamping ring

Compression fittings with PTFE clamping ring can be used several times. They are only pressure-tight up to 10 bar. For assembly, please tighten the connecting nut of the compression fitting by hand as far as it will go (clearly noticeable) by hand. With a wrench suitable for the width across flats, please make a 1/4 turn for compression fittings with PTFE pressure ring.

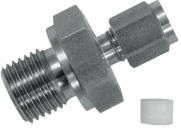
	Article no.	809610 2XXX	Code	I - Ø Inside (mm)	Code	J - Process connection
	Temp. max	+260 °C	0	1	27	M6x1 ¹⁾
	Pressure proof up to	10 bar	1	1,5	28	M8x1 ¹⁾
	Material	Stainless steel 1.4571 316TI	3	3	22	M10x1
	Material clamping ring	PTFE	6	6	14	G1/8 "
	Scope of delivery	Compression fitting, packed in PE bag			12	G1/4 "
					11	G1/2 "
	Your order code	809610 2	-	-	-	-

Append the code for Ø Inside & process connection to the article no. | ¹⁾ not available for Ø Inside (I) 6 mm

Dimensions for technical drawing

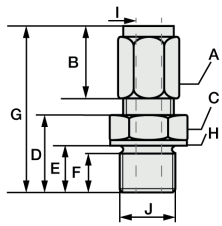

I	J	A	B	C	D	E	F	G	H
1	M6x1 ¹⁾	SW10	13	SW12	13	9	8	31	Ø10
1,5	M8x1 ¹⁾	SW10	13	SW12	13,5	9,5	8	31	Ø11,8
3	M10x1	Ø 1,5 & 3: SW10 Ø 6: SW12	13	SW14	13,5	9,5	8	32	Ø13,8
6	G1/8 "	Ø 1,5 & 3: SW10 Ø 6: SW12	13	SW14	13,5	9,5	8	32	Ø13,8
	G1/4 "	Ø 1,5 & 3: SW10 Ø 6: SW12	13	SW19	20	14	12	38,5	Ø18
	G1/2 "	Ø 1,5 & 3: SW10 Ø 6: SW12	13	SW27	23	17	14	38,5	Ø26

All dimensions in mm | ¹⁾ not available for Ø Inner (I) 6 mm

Compression fitting with stainless steel cutting ring

In compression fittings with stainless steel cutting ring, the compression fitting connects with the protective sleeve. This connection is pressure-resistant up to 40 bar. Therefore, these compression fittings can also only be used once and must be tightened more firmly. For assembly, please tighten the union nut of the compression fitting by hand as far as it will go (clearly noticeable). With a wrench suitable for the wrench size, please make 1 3/4 turns for compression fittings with stainless steel cutting ring.

	Article no.	809610 1XXX	Code	I - Ø Inside (mm)	Code	J - Process connection
	Temp. max	+800 °C	1	1,5	27	M6x1 ¹⁾
	Pressure proof up to	40 bar	3	3	28	M8x1 ¹⁾
	Material	Stainless steel 1.4571 316TI	6	6	22	M10x1
	Material clamping ring	Stainless steel 1.4571 316TI			14	G1/8 "
	Scope of delivery	Cutting ring screw fitting, packed in PE bag			12	G1/4 "
					11	G1/2 "
	Your order code	809610 1	-	-	-	-

Append the code for Ø Inside & process connection to the article no. | ¹⁾ not available for Ø Inside (I) 6 mm

Dimensions for technical drawing

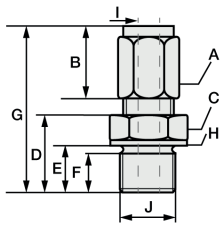

I	J	A	B	C	D	E	F	G	H
1,5	M6x1 ¹⁾	SW10	13	SW12	13	9	8	31	Ø10
3	M8x1 ¹⁾	SW10	13	SW12	13,5	9,5	8	31	Ø11,8
6	M10x1	Ø 1,5 & 3: SW10 Ø 6: SW12	13	SW14	13,5	9,5	8	32	Ø13,8
	G1/8 "	Ø 1,5 & 3: SW10 Ø 6: SW12	13	SW14	13,5	9,5	8	32	Ø13,8
	G1/4 "	Ø 1,5 & 3: SW10 Ø 6: SW12	13	SW19	20	14	12	38,5	Ø18
	G1/2 "	Ø 1,5 & 3: SW10 Ø 6: SW12	13	SW27	23	17	14	38,5	Ø26

All dimensions in mm | ¹⁾ not available for Ø Inner (I) 6 mm

RS / KS / 28.10.2021



Matching accessories: Thermocouple cables

Thermocouple cables - Please select your desired cable first.											
Order code	Type	Color	IP	From (°C) ¹⁾	To (°C) ¹⁾	Outside material	Material strand	Ø (mm) ²⁾	Q (mm ²)	Color strand	Ω / m ⁴⁾
809300 2	Thermocouple cable	Type K ³⁾	IP67	-30	+105	PVC	PVC	3,8	0,22	gn, wt	4,50

Insulation resistance: ≥ 100 MOhm at min. 100 VDC | ¹⁾per. °C range | ²⁾Tolerance ± 0.2 mm | ³⁾ Color according to IEC 584 | ⁴⁾per thermocouple

Now please select the length and add the code to the article no. of the cable.

Length (m)	1	2	5	10	20
Code	010	020	050	100	200

Please append these digits to the part number of your desired cable.

Matching accessories: Connector

Connector					
Picture	Code	Feature	Picture	Code	Feature
	809140 2000	Mini-TC connector Type K gn		809100 2000	Mini-TC coupling Type K gn
	809150 2000	TC connector Type K gn		809110 2000	TC coupling Type K gn
	809140 2001	Mini-TC connector Type K ye		809100 2001	Mini-TC coupling Type K ye
	809150 2001	TC connector Type K ye		809110 2001	TC coupling Type K ye

Other connectors available on request

Technical drawing - Connector

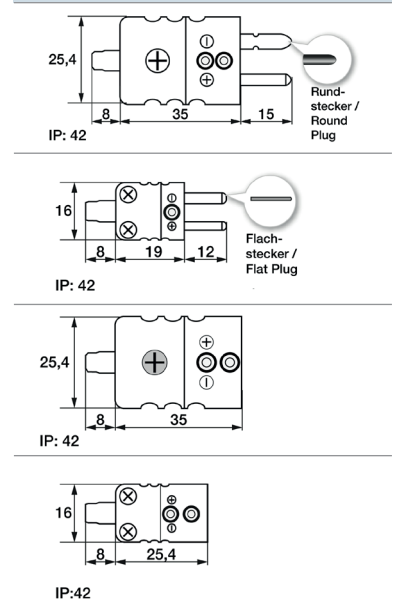

Matching accessories: Heat-conducting paste

Heat-conducting paste		
Article no.	809540 1000	
Content	10 ml	
Thermal conductivity	>2.5 W/mK	
Min / Max °C	-30 °C to +280 °C	
Thermal resistance	< 0.126	

Matching accessories: Quick-release strap

Quick-release strap						
Article no.	Picture	809550 1000	Picture	809550 2000	Picture	809550 3000
Clamping range (mm)		Ø 25 bis 40		Ø 30 bis 110		Ø 25 bis 135
Material		Stainless Steel		Stainless Steel		Stainless Steel
Dimensions (L/W) (mm)		150 ¹⁾ / 9 ²⁾		370 ¹⁾ / 10		450 ¹⁾ / 9 ²⁾
Closure		Quick release		Quick release		Quick release

RS / KS / 28.10.2021

¹⁾± 5 mm | ²⁾± 0,5 mm

