

Thermocouple type K M6 with silicone cable

Order nr.: 803161 2211

Screw-in thermocouples with silicone cable measure the temperature in pipes or vessels and can be used from -50 °C to +180 °C. Silicone seals well and remains flexible even at temperatures below freezing. To configure your screw-in thermocouple for your measurement task, simply select the required configuration features and send us the order code.

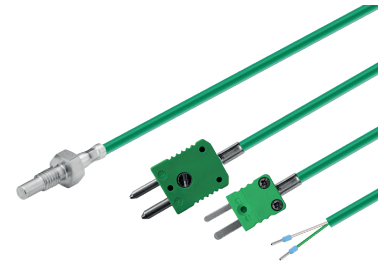

General Information	
Measuring range	-40 °C to +180 °C
Perm. °C range cable	-50 °C to +180 °C
Accuracy	-40 °C to +375 °C: ±1,5 °C according to DIN IEC 60584 Class 1
Response time	t63 / t99: information is available on request
Pull-out force	≥ 30 N
Supply and output	
Measuring element	Thermocouple Type K
Measuring point	Measuring point isolated
Measurement signal	Thermovoltage
Ambient conditions	
Protection class	IP65 according DIN 60529 (depending on cable)
Humidity and moisture condensation resistance	according to application-specific qualification
Certificates and Standards	
Standards	DIN EN 61326-1:2013 DIN EN IEC 63000:2019-05
Directive	RoHS 2011/65/EU 2014/30/EU
Certificates	Certificate of suitability (on request)



Customizable options
 E - Material connection cable
 F - Length connection cable
 G - Connector
 H - Bend protection

Screw-in thread					
Bild	Screw-in thread		Bild	Protection sleeve	
	Material	Stainless steel 1.4301 SUS 304		Material	Stainless steel 1.4301 SUS 304
	Length (mm)	9		Mounting length (mm)	17
	Process connection	M6		Ø (mm)	4,5 ¹⁾
	Wrench size	10			

other protective sleeve lengths and Ø available on request | ¹⁾ Tolerance ± 0,1 mm |

E - Cable material and configuration connection cable											
	Code	Type	Color	From (°C) ¹⁾	To (°C) ¹⁾	Outside material	Material strand	Ø (mm) ²⁾	Q (mm ²)	Color strand	Ω / m ⁴⁾
	E8220	Thermocouple cable	Type K ³⁾	-50	+180	Silicone	FEP	3,6	0,22	gn, wt	4,50

Insulation resistance: ≥ 100 MOhm at min. 100 VDC | ¹⁾Perm. range °C | ²⁾Tolerance ± 0,2 mm | ³⁾Color according to IEC 584 | ⁴⁾per thermocouple

F - Length								
Code	F010	F020	F030	F040	F050	F100	F150	F200
m	1	2	3	4	5	10	15	20

Other lengths on request

RL / KS / 29.07.2021



G - Connector					
Picture	Code	Feature	Picture	Code	Feature
	G01	Insulated end ferrules (50 mm)			
	G12	Mini-TC connector Type K gn		G32	TC connector Type K gn
	G19	Mini-TC connector Type K ye		G39	TC connector Type K ye

Other connectors available on request

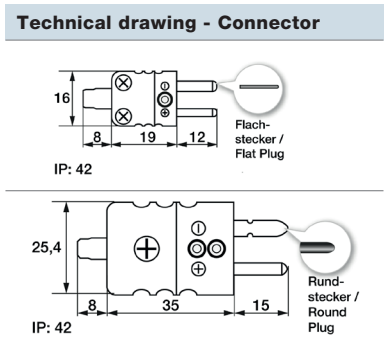

H - Bend protection		
Picture	Length (mm)	Material
	50	Stainless steel spring 1.4310 SUS 302
	Code	Feature
	H0	Without (Standard)
	H1	Metal bend protection ¹⁾

¹⁾on request

Delivery and Assembly	
Assembly instructions	per process connection
Delivery and Packaging	Probe, separately packaged in PE bag

Your order code				
Order nr.	Material connection cable	Length connection cable	Connector	Bend protection
803161 2211	E_____	F_____	G_____	H_____

Important assembly advices

Measurement errors can occur due to heat dissipation to the environment. To keep these as small as possible, we recommend immersing the protection sleeve of your temperature probe as deeply as possible in the medium to be measured during installation. The optimum installation depth should be 10-15 times the Ø of the protection sleeve or, when using an immersion sleeve, the Ø of the immersion sleeve. When installing in pipelines whose Ø does not have a sufficiently deep installation depth, you should install the probe either at an angle or in a pipe elbow. Make sure that there is sufficient space for the probe to be removed. 1) Installation with sufficient installation depth 2) Installation at an angle with small pipe Ø 3) Not like this: Minimum installation depth not reached

Please lay the cable in such a way that no water can penetrate the probe and with reserve loop (4). This allows you to extend the probe without disconnecting the electrical connection.

RL / KS / 29.07.2021



Technical drawing

Customizable options

E - Material connection cable
 F - Length connection cable

F - Length connection cable
 G - Connector
 H - Bend protection

All dimensions in mm

Version with insulated end ferrules

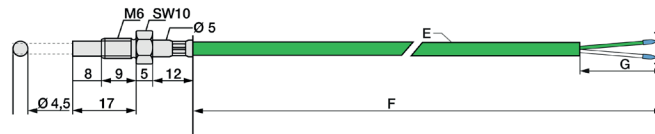

Version with mini TE connector

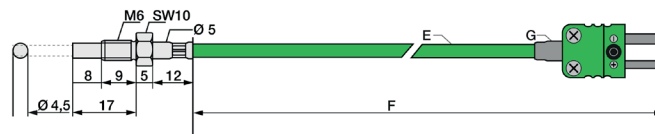

Version with TE connector

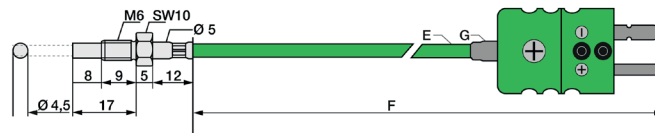

Version with mini TE connector

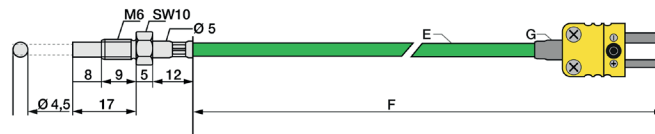

Version with TE connector

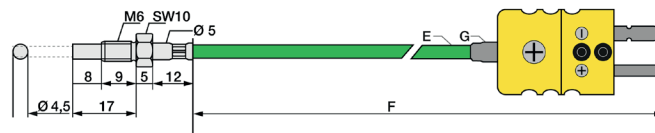

Matching accessories: Thermocouple cables & Connector

Thermocouple cables - Please select your desired cable first.											
Order code	Type	Color	IP	From (°C) ¹⁾	To (°C) ¹⁾	Outside material	Material strand	Ø (mm) ²⁾	Q (mm ²)	Color strand	Ω / m ⁴⁾
809310 2	Thermocouple cable	Type K ³⁾	IP67	-50	+180	Silicone	FEP	3,6	0,22	gn, wt	4,50

Insulation resistance: ≥ 100 MOhm at min. 100 VDC | ¹⁾per. °C range | ²⁾Tolerance ± 0.2 mm | ³⁾ Color according to IEC 584 | ⁴⁾per thermocouple

Now please select the length and add the code to the article no. of the cable.					
Length (m)	1	2	5	10	20
Code	010	020	050	100	200

Please append these digits to the part number of your desired cable.

Matching accessories: Connector

Connector					
Picture	Code	Feature	Picture	Code	Feature
	809140 2000	Mini-TC connector Type K gn		809100 2000	Mini-TC coupling Type K gn
	809150 2000	TC connector Type K gn		809110 2000	TC coupling Type K gn
	809140 2001	Mini-TC connector Type K ye		809100 2001	Mini-TC coupling Type K ye
	809150 2001	TC connector Type K ye		809110 2001	TC coupling Type K ye

Other connectors available on request

Technical drawing - Connector

Matching accessories: Heat-conducting paste

Heat-conducting paste	
Article no.	809540 1000
Content	10 ml
Thermal conductivity	>2.5 W/mK
Min / Max °C	-30 °C to +280 °C
Thermal resistance	< 0.126

RL/KS / 29.07.2021

Details of accessories can be found on our website.

